

F E D C B A

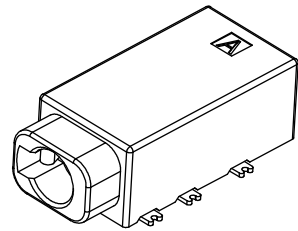

3D VIEW

1. CONTACT CURRENT RATING: 1A.
2. CONTACT RESISTANCE: 100 mΩ MAX.;
3. INSULATION RESISTANCE: 100MΩ MIN.;
4. DIELECTRIC WITHSTANDING: 500V AC MIN.;
5. DURABILITY: 5,000 CYCLES MIN.;
6. CONNECTOR MATING FORCES: 30N MAX.;
7. CONNECTOR UNMATING FORCES: 3N MIN.;
8. TERPROOF LEVEL: IPX7;

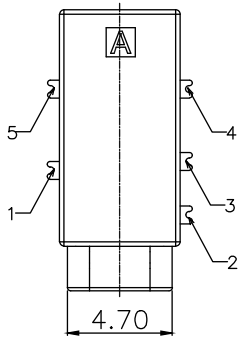
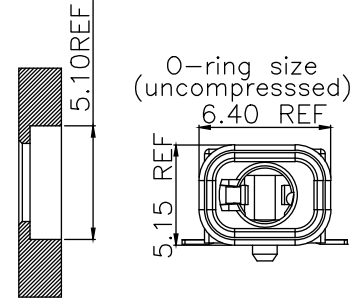

O-ring size (uncompressed)

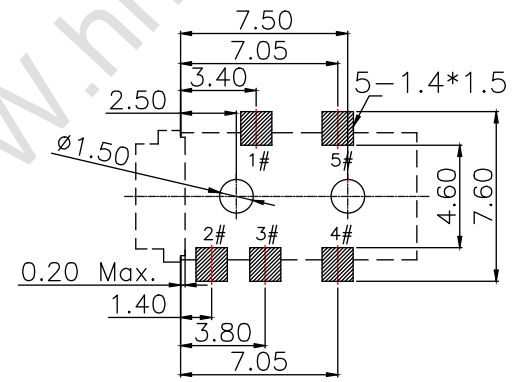
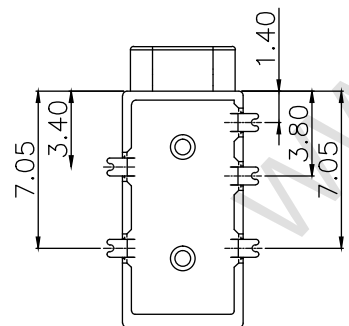
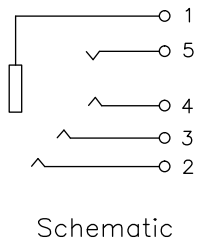
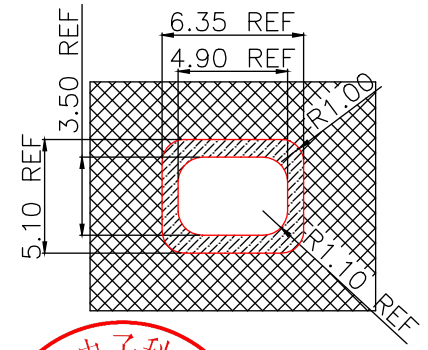
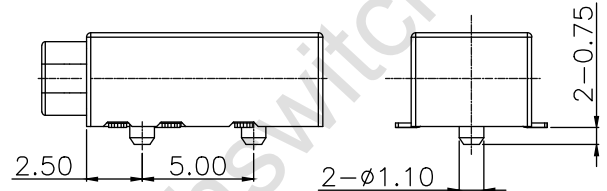
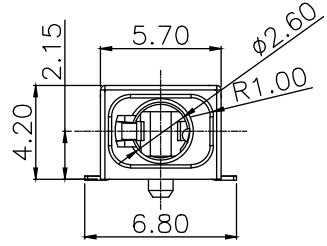
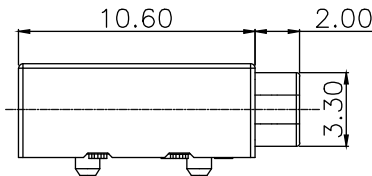

RECOMMENDED P.C.B LAYOUT TOP VIEW (TOLRANCE:±0.05)

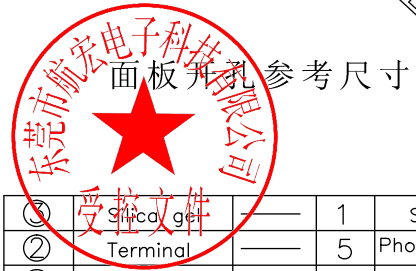

面板开孔参考尺寸

ITEM	PART NAME	TER'NO.	QTY.	MATERIAL	FINISHING
①	Silica gel	—	1	Silica gel	Black
②	Terminal	—	5	Phosphor bronze	Au Plating
①	Housing	—	1	HTP	Black

DESIGN	MISS ZENG	SC ALL		TOLERANCE	ANGLES
DRAWIGN	MISS LI	ANIT	mm	X.X ±0.30	X. ±2
CHECK	Mr. ZENG	SIZE	A4 : 210*297	.XX ±0.20	.X ±1
APPROVAL		VERSION	01	.XXX ±0.10	.XX ±0.5

品名: 防水耳机插座
型号: PJ-431



东莞市航宏电子科技有限公司
Dongguan Hanghong Electronics Co., Ltd.

F E D C B A